

# Concept 14.4: Many human traits follow Mendelian patterns of inheritance

- Humans are not good subjects for genetic research
  - Generation time is too long
  - Parents produce relatively few offspring
  - Breeding experiments are unacceptable
- However, basic Mendelian genetics endures as the foundation of human genetics

# Pedigree Analysis

- A **pedigree** is a family tree that describes the interrelationships of parents and children across generations
- Inheritance patterns of particular traits can be traced and described using pedigrees

- Pedigrees can also be used to make predictions about future offspring
- We can use the multiplication and addition rules to predict the probability of specific phenotypes

# Sample Pedigree

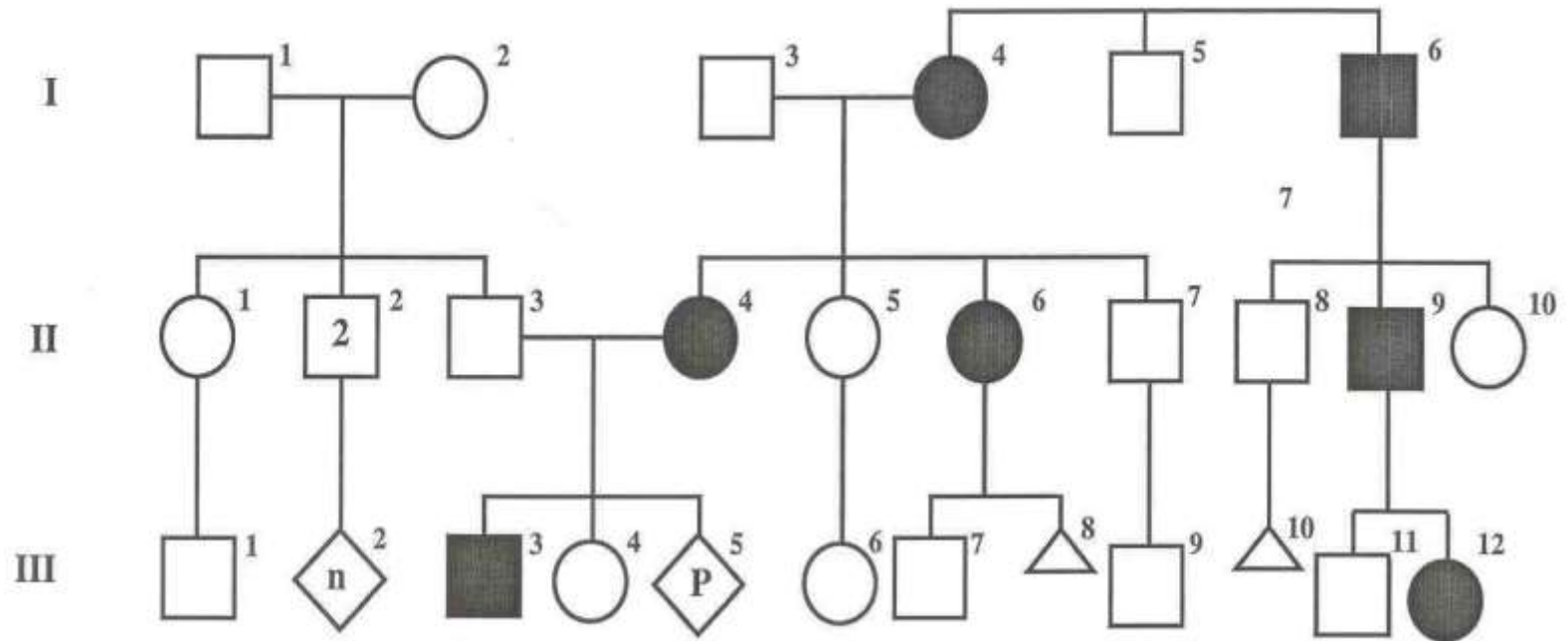

# IMPORTANT TERMS

locus	codominant	compound heterozygote
allele	dominant	carrier (obligate heterozygote)
genotype	recessive	genetic heterogeneity
phenotype	homozygous	pleiotropy
autosomal	heterozygous	age of onset
X-linked	hemizygous	sex-limited
penetrance	expressivity	sex-influenced
pedigree	proband	imprinting
trinucleotide repeat		

A **pedigree** is a concise summary of the medical family history; it is the symbolic language of clinical genetics and human genetics research.

- It is an easy, fast, and efficient means of recording a wealth of information about the family.
- Standardization of symbols is essential to facilitate communication - See Robin Bennett's article referenced in resources at the end of the syllabus for more details if interested.
- Nomenclature is an evolving process.
- Several ethical and legal dilemmas - Potential for discrimination, issues of privacy raised, and need for guidelines.

I

II

III

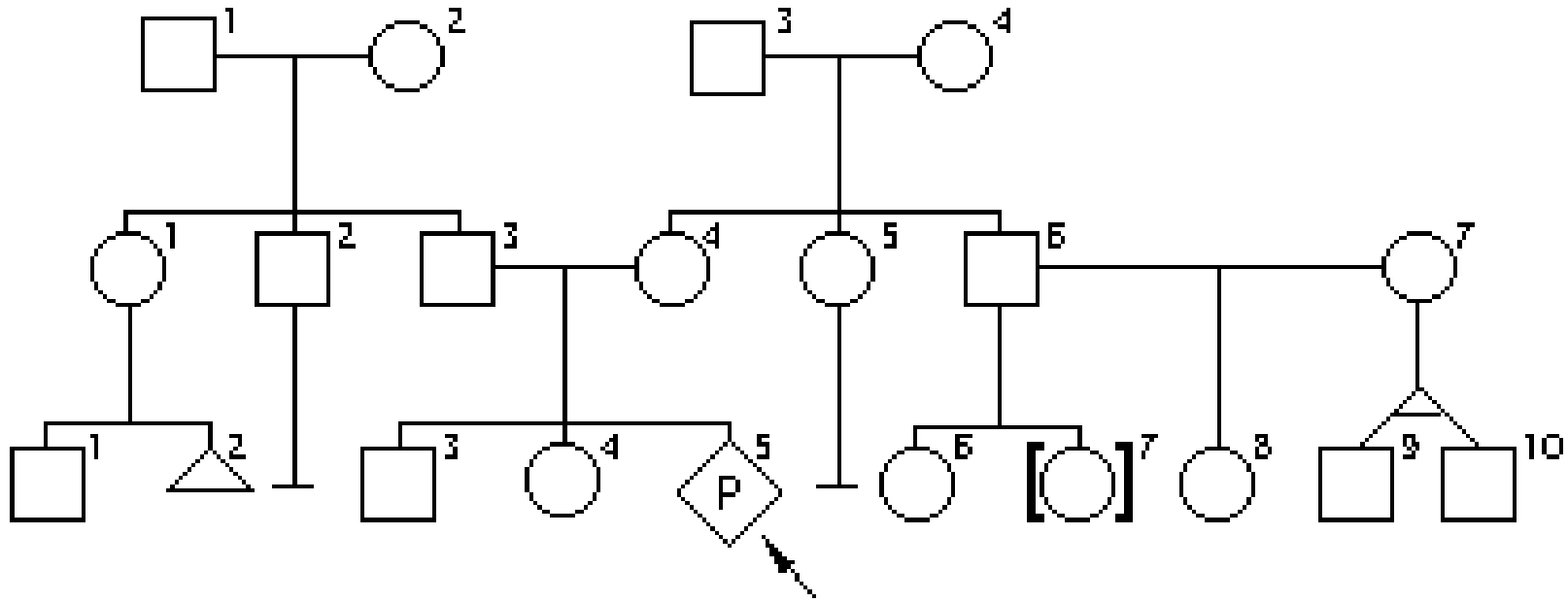

# Designation of generations and individuals

1. Each horizontal line is a generation
2. Place the oldest generation at the top
3. Use Roman numerals to identify generations
4. Use Arabic numbers to identify individuals within a generation
5. List siblings from oldest to youngest, from left to right
6. Male partner is usually placed to the left of the female partner
7. Record full name, current age and date of birth, or age at death for each individual
8. Record race and ethnic origin of each individual
9. Note health problems and/or cause of death for each individual
10. There are appropriate symbols to use for both adoption and assisted-reproductive technologies

- The proband is an affected individual coming to medical attention independently of other
- family members. The proband is designated with an arrow in the pedigree, and there may be more than one proband per family.

# Medical status and results of genetic evaluation/testing of family members

1. Shading or fill (hatches, dots, etc.) is used to denote medical status or symptoms of individuals. A key/legend is used to define meaning
2. Results of an evaluation (E) are recorded below the symbol and a key/legend defines the notations. Currently this is the least standardized pedigree nomenclature

# PEDIGREE NOMENCLATURE

Adapted from Bennett RL et al. (1995) AJHG 56:745-752.

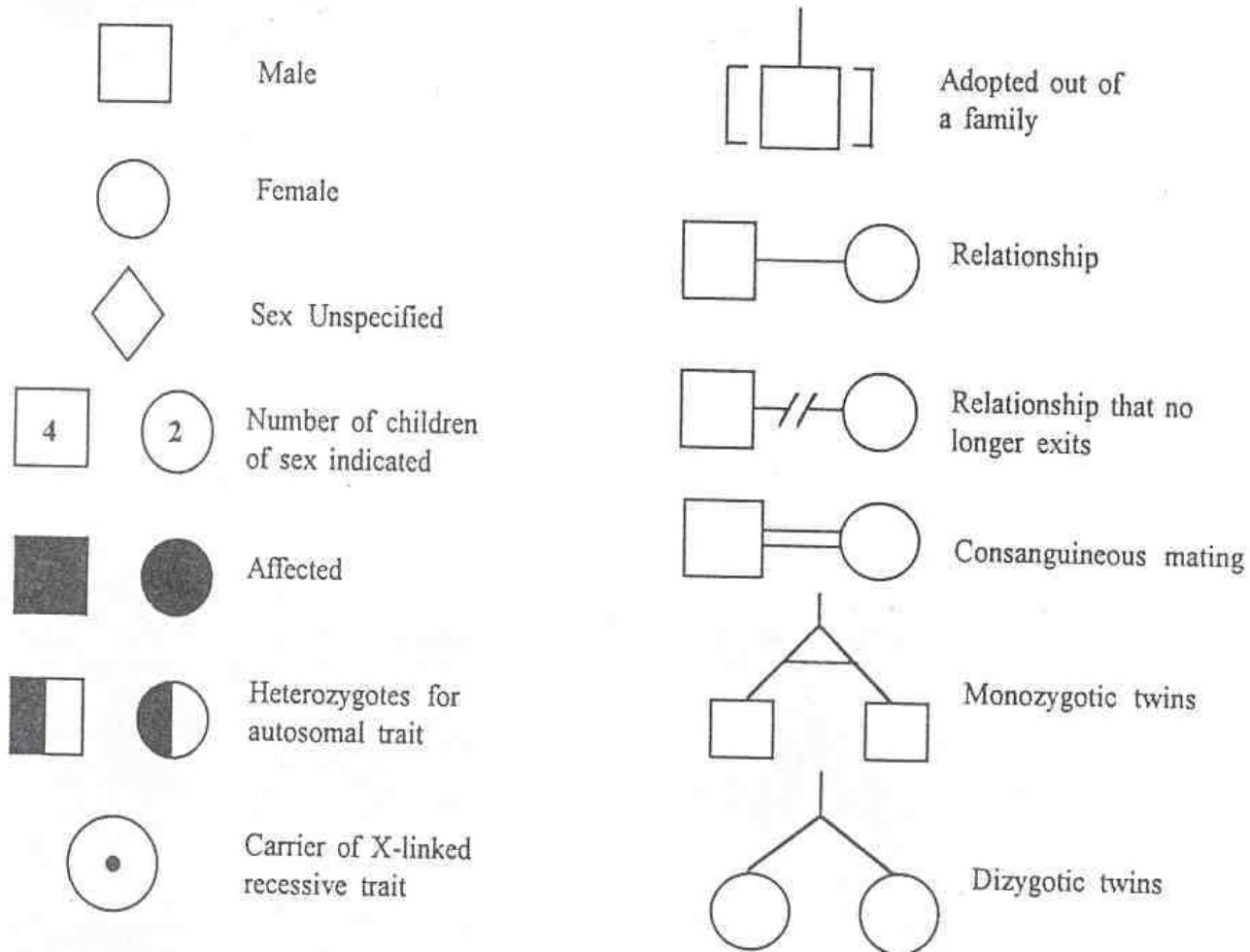

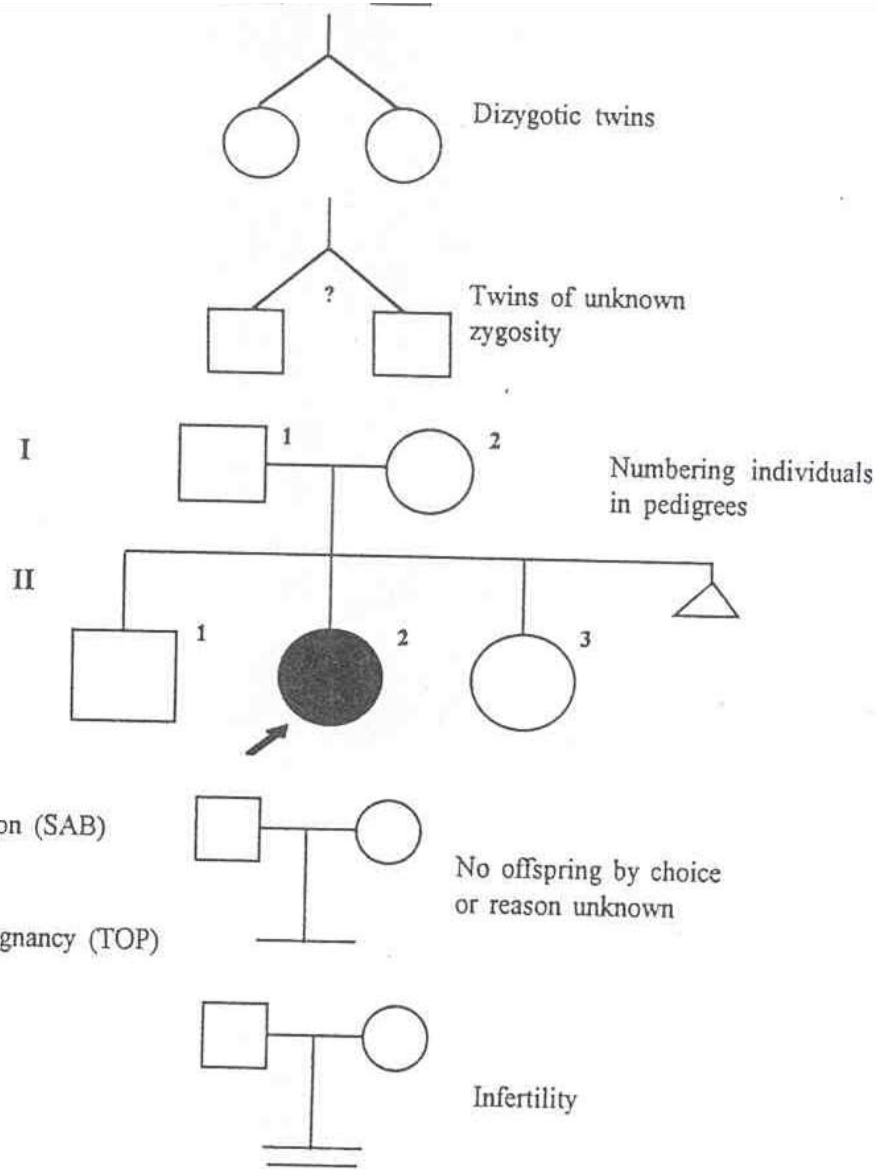
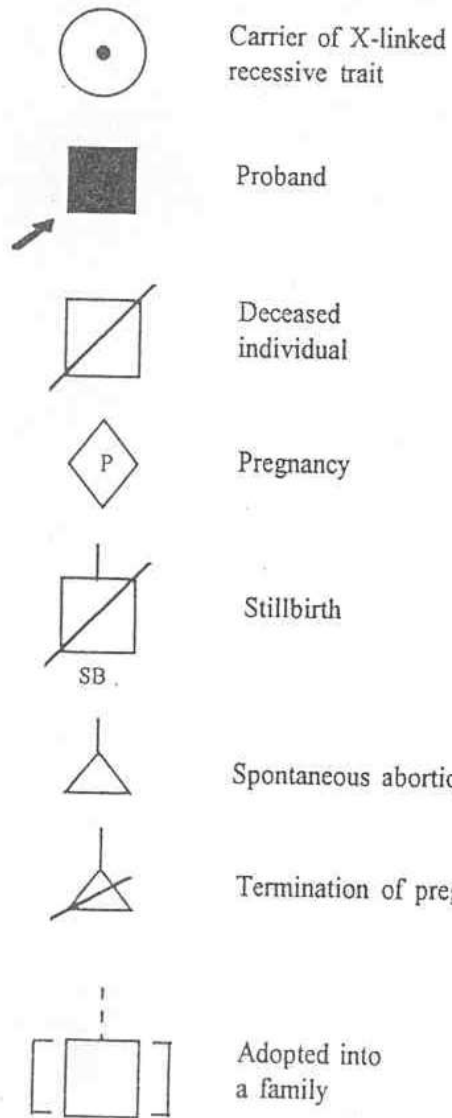

# The Gene is the Unit of Inheritance

The location of a gene on a chromosome is its **locus**.

Alternative forms of a gene at a particular locus are referred to as **alleles**.

An individual's **genotype** (genetic composition) at a particular locus is defined by the nature of the alleles at that locus

If both alleles are identical, then the individual is **homozygous** at the locus. Homozygosity may refer to the presence of two normal or two mutant alleles.

If the alleles differ, then the individual is **heterozygous** at the locus. If two different mutant alleles are present, then the individual is a **compound heterozygote**.

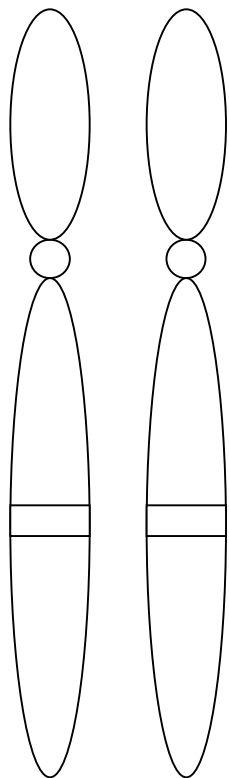

**A A**

homozygote

A allele

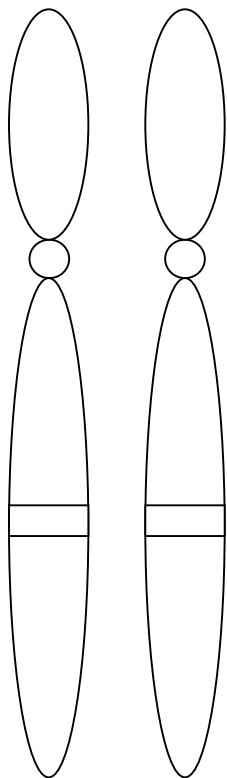

**A a**

heterozygote

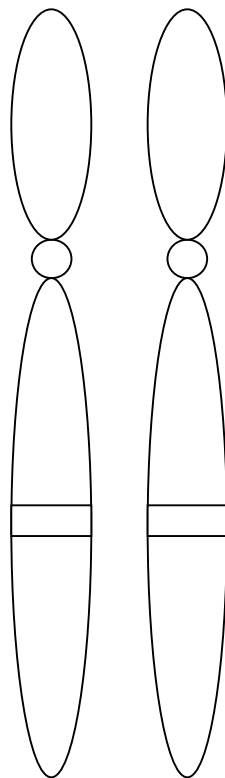

**a a**

homozygote

a allele

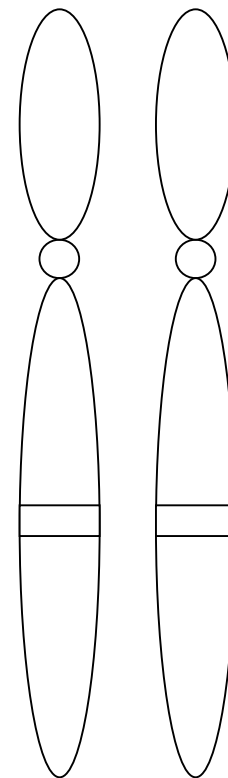

**a1 a2**

compound  
heterozygote

The genotype at a particular locus and the environment in which it is expressed determines the phenotype or observed characteristics of an individual.

Traits that are determined by loci on one of the 22 autosomes are **autosomal**. Traits determined by loci on the X chromosome are **X-linked**, and those determined by loci on the Y chromosome are **Y-linked**.

# Gregor Mendel's Laws of Inheritance

- Law of Unit Inheritance - parental characteristics do not blend because there is a unit of inheritance. Mendel's "units" are now known as genes or alleles.
- Law of Segregation - the two alleles at a particular locus segregate into different gametes.
- Law of Independent Assortment - alleles at different loci are transmitted independently of each other. Linkage is an exception to this rule.

# Dominant and Recessive Inheritance

- Nomenclature: For dominant traits the capital letter (e.g. A) represents the mutant allele and the small letter (e.g. a) represents the normal allele. For recessive traits, the small letter (e.g. a) represents the mutant allele and the capital letter (e.g. A) represents the normal allele.
- **Autosomal dominant traits** are those traits in which the phenotype of the heterozygote and the homozygote for the dominant allele are the same, i.e., Aa and AA have the same phenotype where A=dominant allele. These traits are expressed when only one copy of the dominant allele is present. In practice, if the heterozygote expresses the trait, then the trait is classified as dominant, even if the phenotype of the homozygote (AA) and heterozygote (Aa) are different.
- **Autosomal recessive traits** are those traits in which the phenotype is expressed only if homozygous for the recessive allele, i.e., aa where a=recessive allele. Two copies of the recessive allele are necessary for expression.

# Dominant and Recessive Inheritance

- If the heterozygote (AB) has a different phenotype than either of the homozygotes (AA or BB), then the alleles are said to be **codominant**.
- **X-linked dominant traits** are those expressed when either males or females have one copy of the dominant allele, i.e.,  $X^AY$  or  $X^AX^a$  where A=dominant allele.
- **X-linked recessive** traits are those expressed in males who carry one copy of the recessive allele (i.e., are hemizygous,  $XaY$  where a=recessive allele). Two copies of the recessive allele are generally required for females to express the trait, i.e.,  $XaXa$ .

# Types of Genetic Disease

- Chromosomal
- Single gene (Mendelian)
- Multifactorial
- Teratogenic

# Examples and Features of Autosomal Dominant Inheritance



**Affected  
individual**

**Unaffected  
individual**

**A=mutant allele  
a=normal allele**

# Examples

- familial hypercholesterolemia
- Huntington disease
- neurofibromatosis type I (NF1)
- myotonic dystrophy
- Marfan syndrome
- achondroplasia

DISEASE	CLINICAL FEATURES Note: Key aspects of phenotypic expression or inheritance features are bolded
<u>Autosomal Dominant</u>	
HUNTINGTON DISEASE	Progressive loss of brain neurons, dementia, loss of motor control Affects 1/20,000 persons of European descent <b>Late onset, typically between 30-40 years, but may be earlier</b> (See lecture on unstable trinucleotide repeats.)
MYOTONIC DYSTROPHY	Facial weakness Cataracts Progressive muscular weakness <b>Variable onset</b> <b>Variable expressivity</b>
NEUROFIBROMATOSIS TYPE I (NFI)	Cafe-au-lait spots ( <u>hyperpigmented skin</u> ) <u>Lisch nodules</u> (benign growths on the iris) Peripheral nerve tumors <b>Variable expressivity</b> High mutation rate
FAMILIAL HYPERCHOLESTEROLEMIA,	Arteriosclerosis, xanthomas <b>Heterozygotes: Increased LDL coronary heart disease in middle age</b> <b>Homozygotes: childhood coronary heart disease</b>
MARFAN SYNDROME (Connective tissue disorder)	Tall stature with long limbs Narrow facies with high, narrow palate Dislocated lenses & myopia Cardiac manifestations, i.e., aortic aneurysm <b>Variable expressivity</b> <b>Pleiotropy</b>
ACHONDROPLASIA	Short-limbed dwarfism <u>Megalocephaly</u> <u>Lordosis &amp; Kyphosis</u> <b>80% new mutations</b> Increased mutations with increasing paternal age

# Dominantly Inherited Disorders

- Some human disorders are caused by dominant alleles
- Dominant alleles that cause a lethal disease are rare and arise by mutation
- *Achondroplasia* is a form of dwarfism caused by a rare dominant allele



Figure 14.17

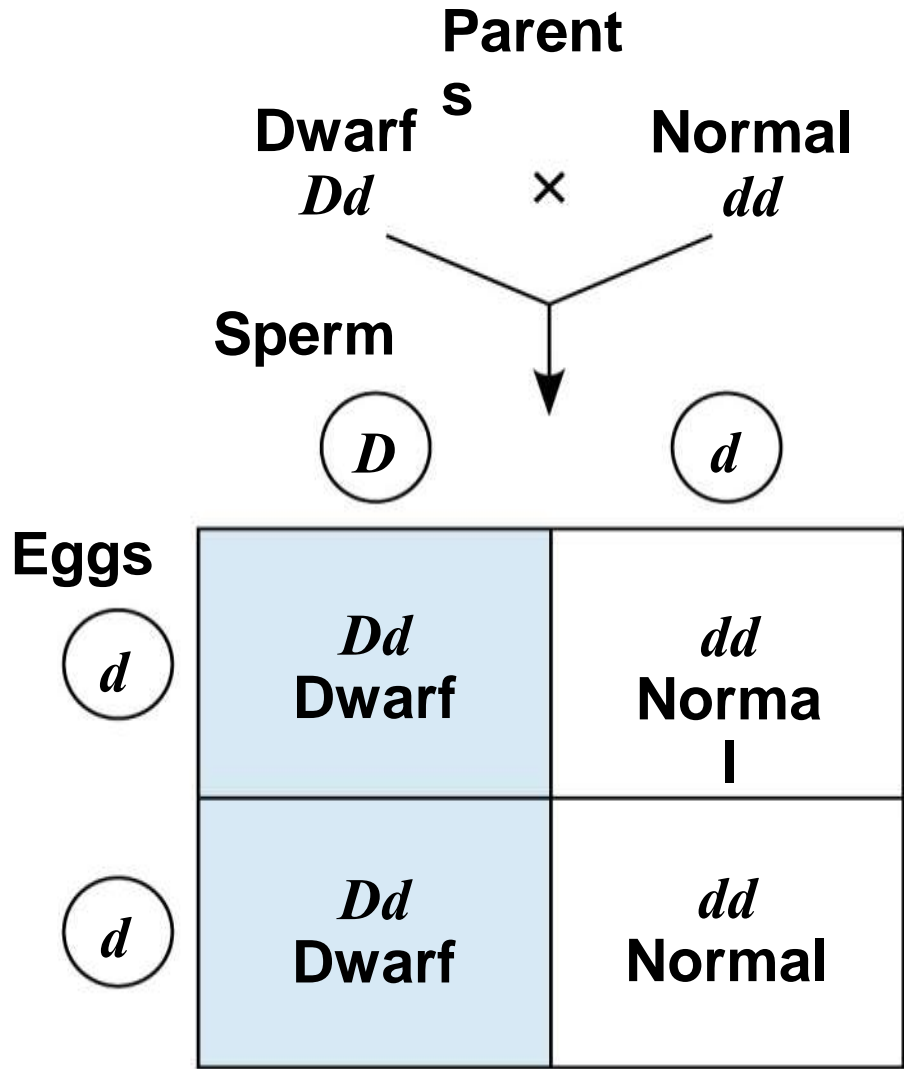

# Achondroplasia



From [www.hopkinsmedicine.org](http://www.hopkinsmedicine.org)



From [www.sciencemuseum.org.uk](http://www.sciencemuseum.org.uk)

# Neurofibromatosis Type 1

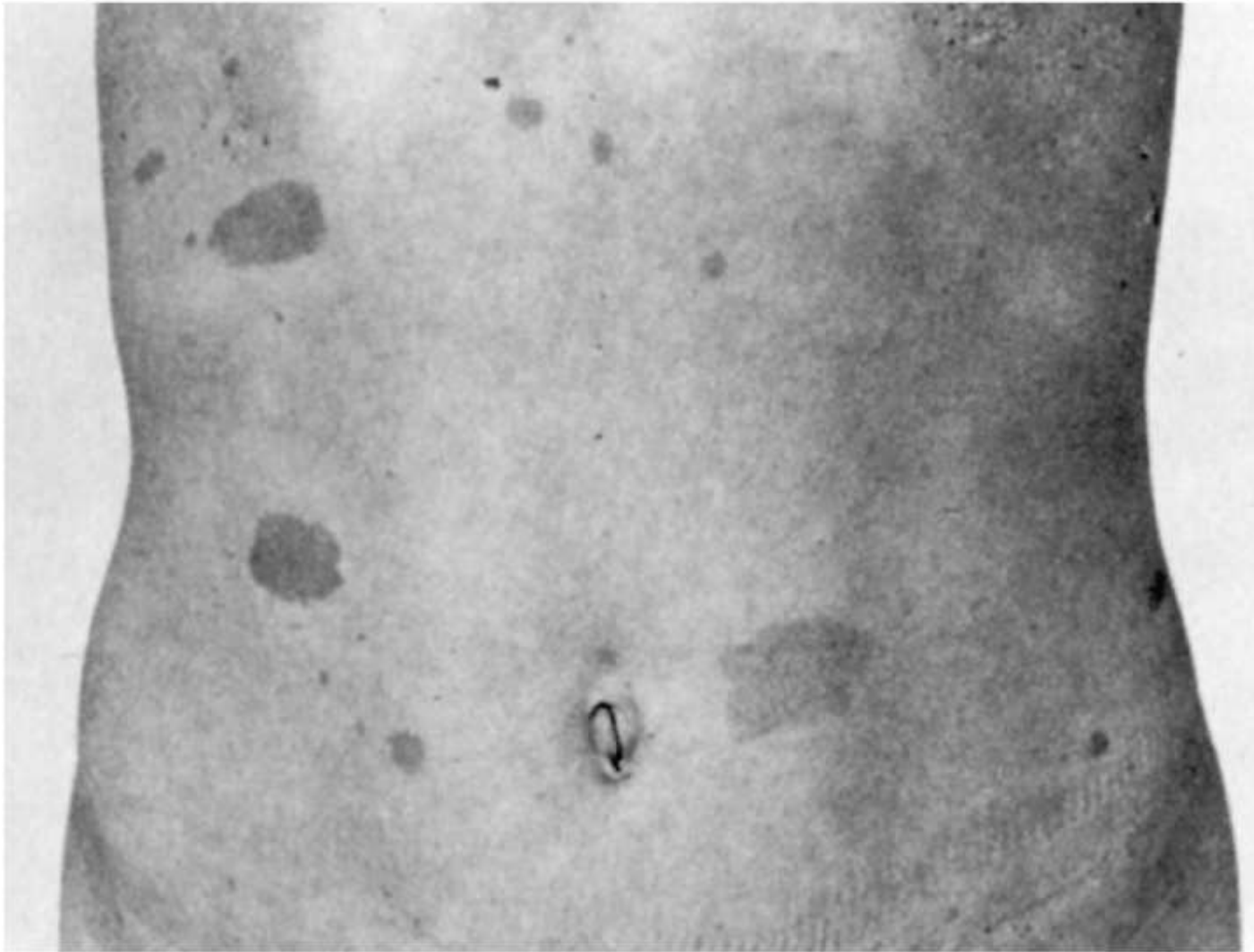

W.B. Saunders Company items and derived items copyright © 2002 by W.B. Saunders Company

# Neurofibromatosis Type 1



# Neurofibromatosis Type 1

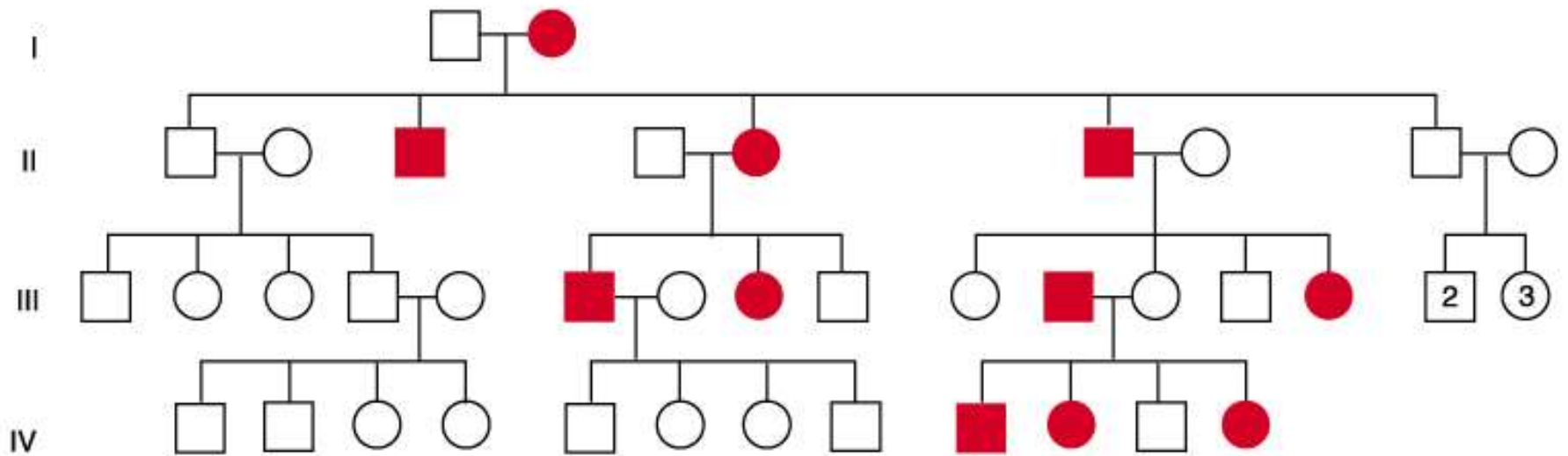

Fig. 121-3.—Recklinghausen neurofibromatosis.

# Features of Autosomal Dominant Inheritance

1. Vertical transmission – direct transmission from grandparent to parent to child without skipping generations
2. Both sexes affected in 1:1 ratio
3. Both sexes may transmit the trait
4. Heterozygotes much more common than homozygotes
5. May see variable expressivity and variable age of onset
6. Homozygotes usually more seriously affected than heterozygotes
7. May be due to new mutation
8. Gene product is usually a structural (non-enzymatic) protein

# Autosomal Dominant Pedigree



W.B. Saunders Company items and derived items copyright © 2002 by W.B. Saunders Company

## Autosomal Dominant Inheritance

(Affected Father)

Parental Gametes

	A	a
a	Aa	aa
a	Aa	aa

Maternal Gametes

1Aa: 1aa

A = mutant, a = normal

# Transmission probabilities and the use of the Punnett square

1. If one parent has the disorder (assumed to be  $Aa$ ) and the other does not ( $aa$ ) then there is a 50% chance that the child will inherit the disorder and a 50% chance that they will not.
2. If both parents have the disorder (assumed to be  $Aa \times Aa$ ) then there is a 75% chance that their children will inherit the disorder, and a 25% chance that they will not.

# **Examples and Features of Autosomal Recessive Inheritance**

# Recessively Inherited Disorders

- Many genetic disorders are inherited in a recessive manner
- These range from relatively mild to life-threatening

# Examples

- cystic fibrosis
- sickle cell anemia
- Tay-Sachs disease
- Phenylketonuria
- most inborn errors of metabolism

# *The Behavior of Recessive Alleles*

- Recessively inherited disorders show up only in individuals homozygous for the allele
- **Carriers** are heterozygous individuals who carry the recessive allele but are phenotypically normal; most individuals with recessive disorders are born to carrier parents
- **Albinism** is a recessive condition characterized by a lack of pigmentation in skin and hair and eyes

Autosomal Recessive

CYSTIC FIBROSIS

Chronic, progressive pulmonary disease  
Pancreatic endocrine insufficiency  
Elevated sweat chloride  
**Higher frequency in European Caucasians**

TAY-SACHS DISEASE

Progressive neurological abnormalities  
Retinal cherry-red spot  
**Higher frequency in the Ashkenazi Jewish and French Canadian populations**  
Reduced serum hexosaminidase A  
Usually fatal in early childhood

SICKLE CELL ANEMIA

Failure to thrive  
Chronic anemia  
Vasocclusive crisis (pain)  
Increased risk for infection  
**Higher frequency in those of African descent**  
Heterozygote advantage

# *Cystic Fibrosis*

- **Cystic fibrosis** is the most common lethal genetic disease in the United States, striking one out of every 2,500 people of European descent
- The cystic fibrosis allele results in defective or absent chloride transport channels in plasma membranes leading to a buildup of chloride ions outside the cell
- Symptoms include **mucus buildup** in some internal organs and abnormal absorption of nutrients in the small intestine

# Cystic fibrosis (CF)

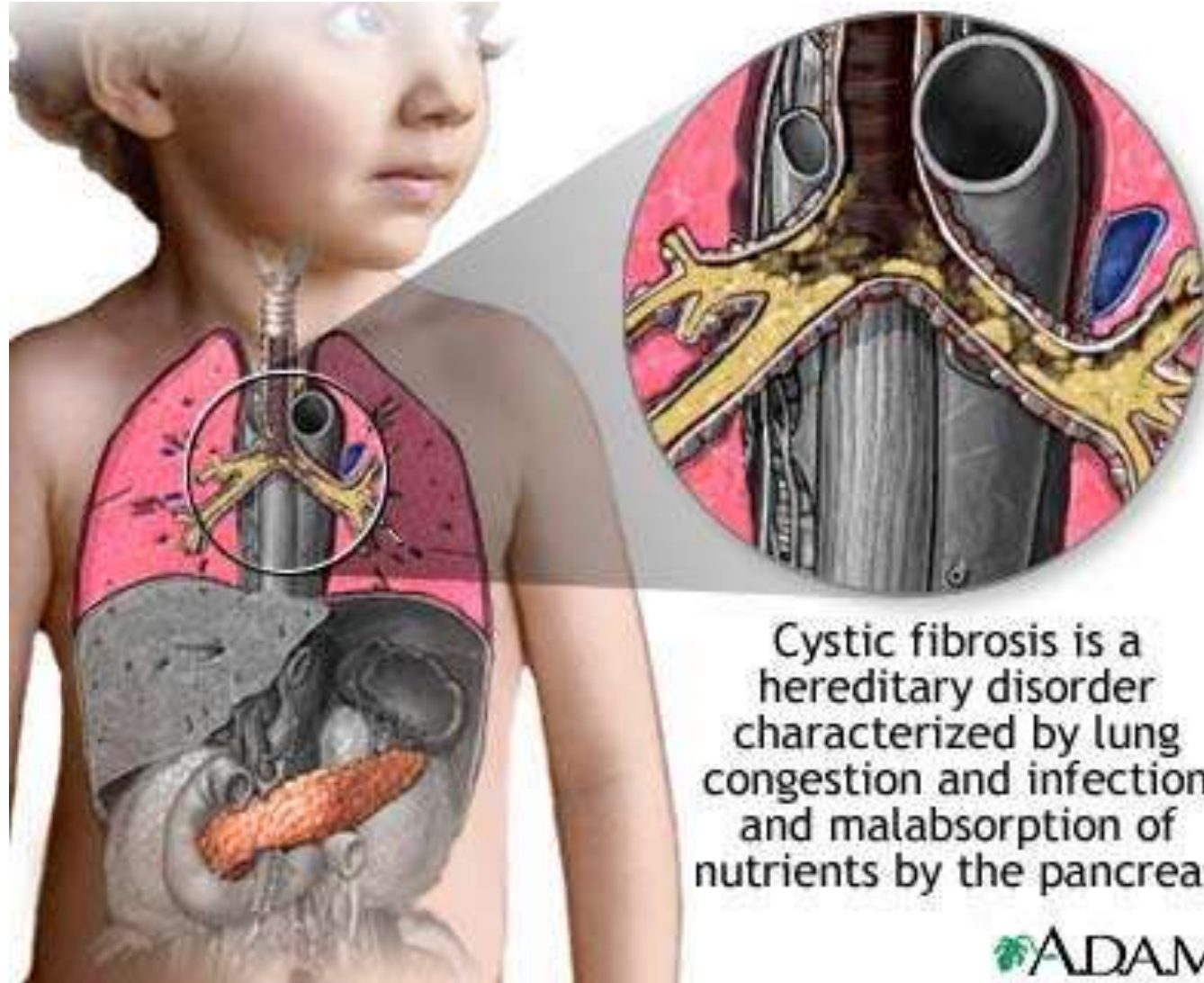

Cystic fibrosis is a hereditary disorder characterized by lung congestion and infection and malabsorption of nutrients by the pancreas

 ADAM.

Photos from  
[www.cff.org](http://www.cff.org)

**A** Organs affected by cystic fibrosis

**Sinuses:**

sinusitis (infection)

**Lungs:** thick, sticky mucus buildup, bacterial infection, and widened airways

**Skin:** sweat glands produce salty sweat.

**Liver:** blocked biliary ducts

**Pancreas:** blocked pancreatic ducts

**Intestines:** cannot fully absorb nutrients

**Reproductive organs:** (male and female) complications

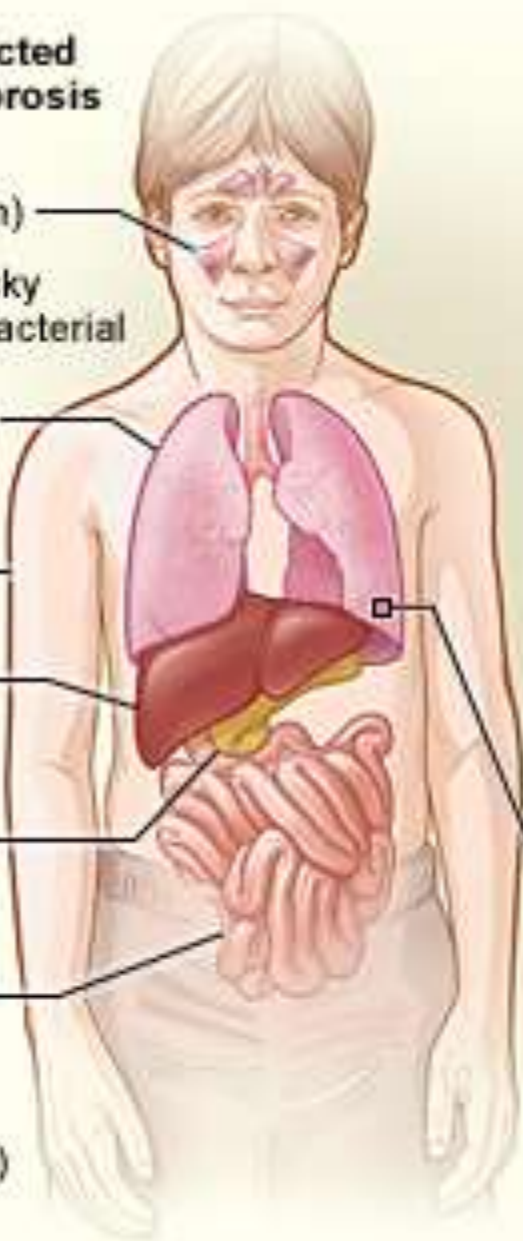

**B** Normal airway

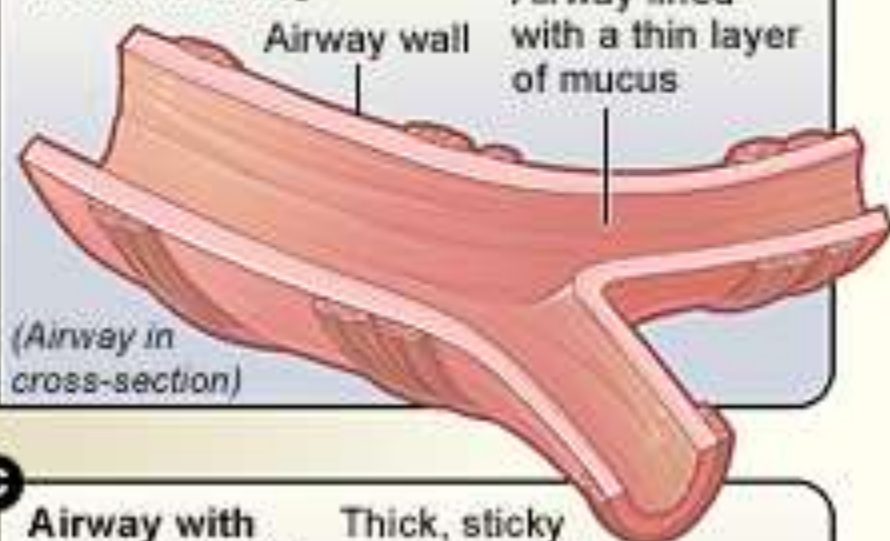

**C** Airway with cystic fibrosis

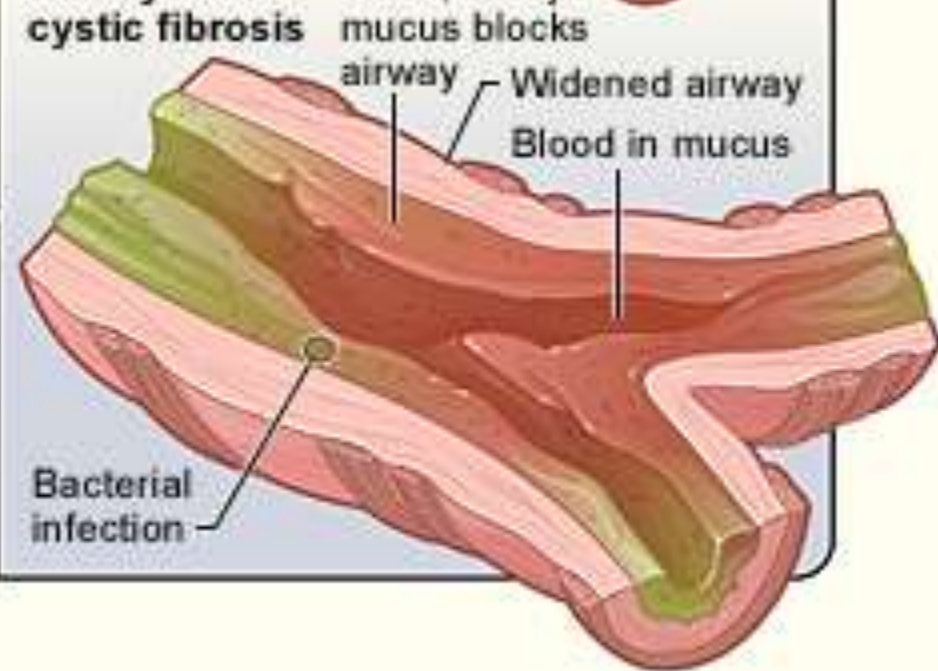
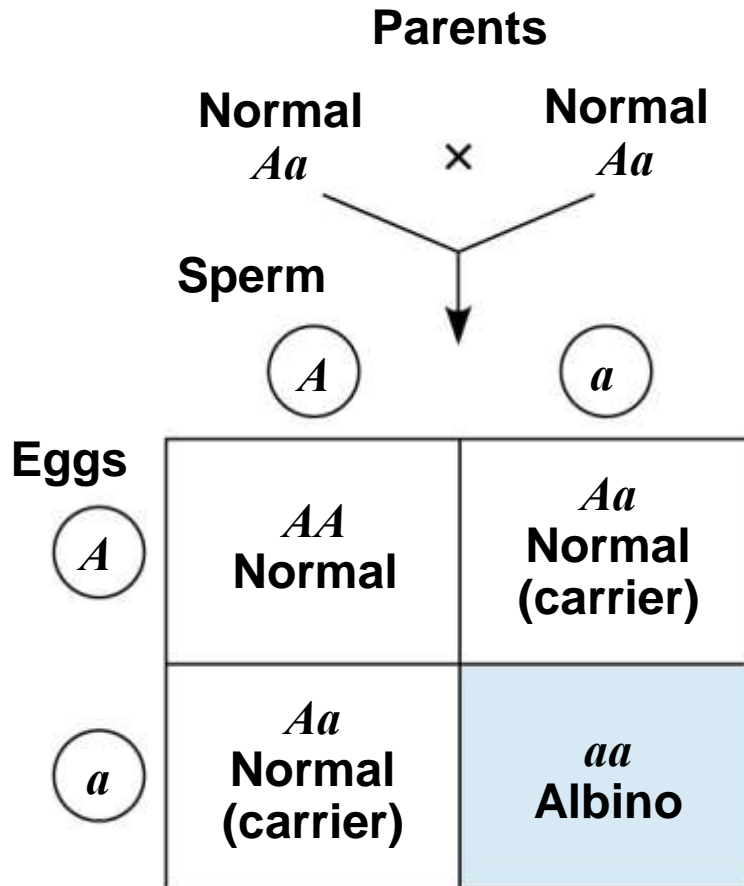

Figure 14.16



- If a recessive allele that causes a disease is rare, then the chance of two carriers meeting and mating is low
- **Consanguineous matings** (i.e., matings between close relatives) increase the chance of mating between two carriers of the same rare allele
- Most societies and cultures have laws or taboos against marriages between close relatives

# *Sickle-Cell Disease: A Genetic Disorder with Evolutionary Implications*

- **Sickle-cell disease** affects one out of 400 African-Americans
- The disease is caused by the substitution of a single amino acid in the hemoglobin protein in red blood cells
- In homozygous individuals, all hemoglobin is abnormal (sickle-cell)
- Symptoms include physical weakness, pain, organ damage, and even paralysis

- Heterozygotes (said to have sickle-cell trait) are usually healthy but may suffer some symptoms
- About one out of ten African Americans has sickle cell trait, an unusually high frequency of an allele with detrimental effects in homozygotes
- Heterozygotes are less susceptible to the malaria parasite, so there is an advantage to being heterozygous

# Sickle Cell Anemia



---

# Phenylketonuria

- PKU is an inherited disorder that increases the levels of phenylalanine in the blood
  - Due to defective hepatic enzyme phenylalanine hydroxylase (PAH) .
  - Necessary to metabolize the amino acid phenylalanine ('Phe') to the amino acid tyrosine
-

## Symptoms

- Elevated phenylalanine, phenylpyruvate, phenyllactate and phenylacetate in blood and urine (musty odor of urine).
  - Neurological problems** (mental retardation, seizures, tremors, microcephaly etc) due to reduced production of catecholamines.
  - Hypopigmentation** (light skin, hair, blue eyes) due to reduced melatonin production.
- NO COMPLETE LOSS OF PIGMENT B/C  
WILL STILL HAVE SOME TYROSINE FROM DIET

## Normal

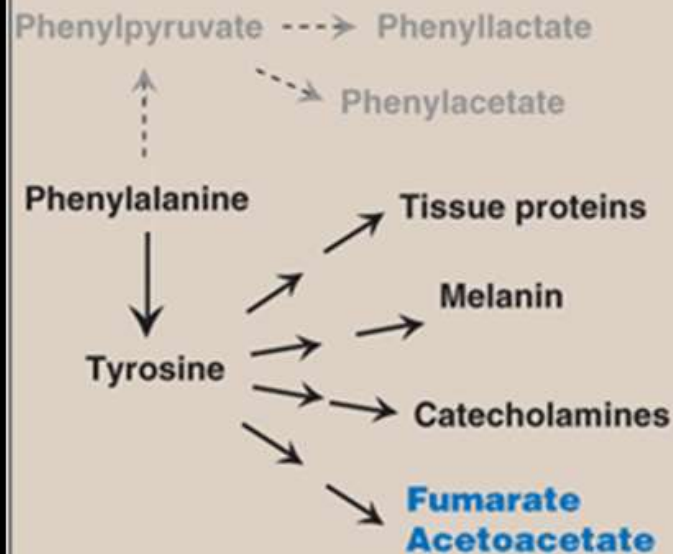

## Phenylketonuria

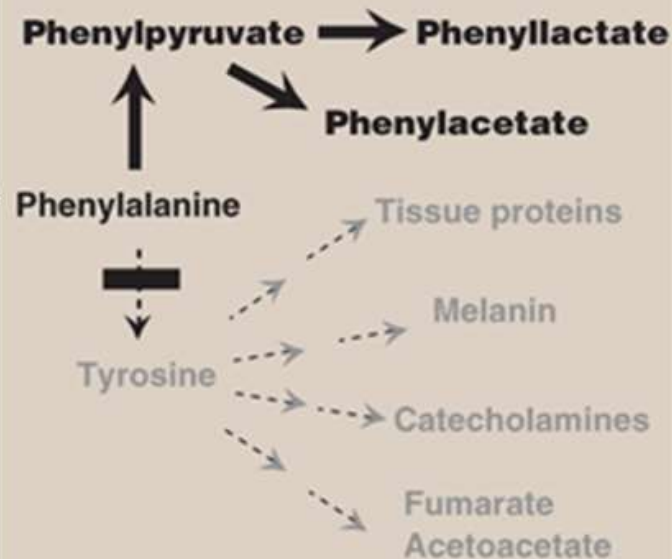

# Autosomal Recessive

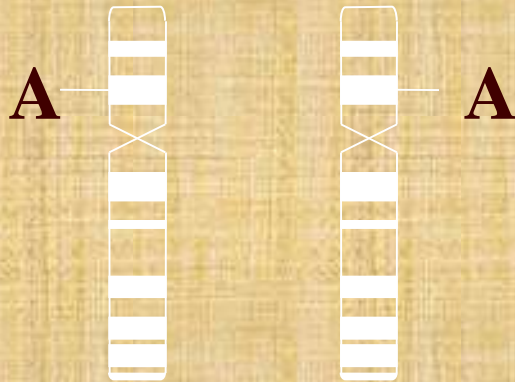

Unaffected, not a carrier

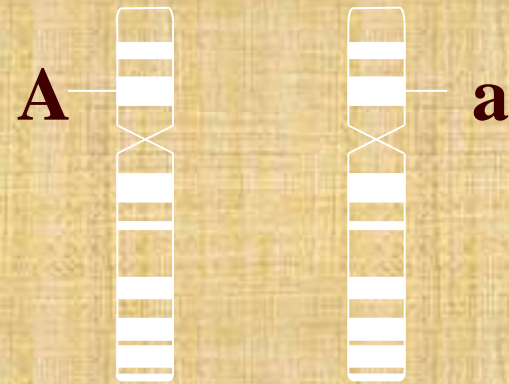

Carrier, unaffected

**A=normal allele**  
**a=mutant allele**

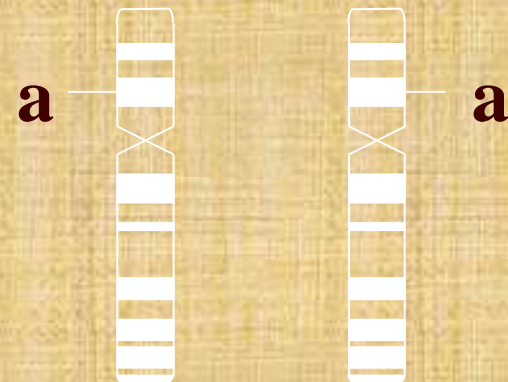

Affected

# Autosomal Recessive Pedigree

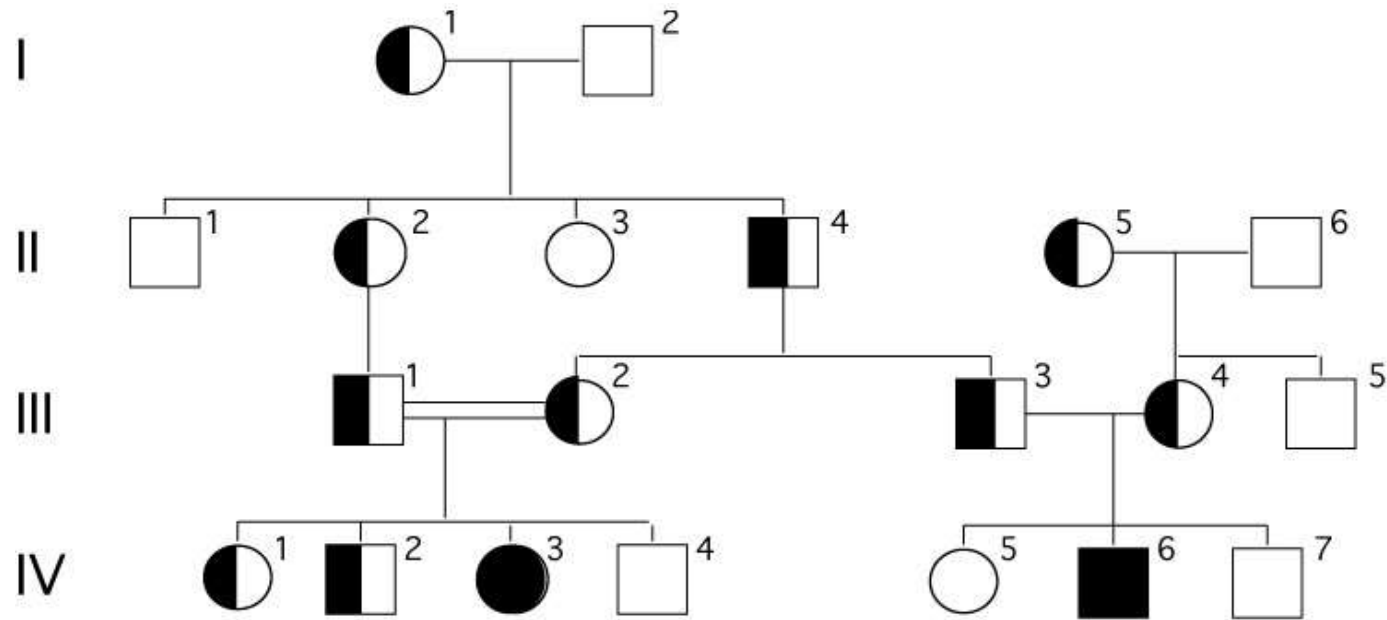

- Normal
- ◐ Heterozygous carrier
- Homozygously affected

# Autosomal Recessive Pedigree

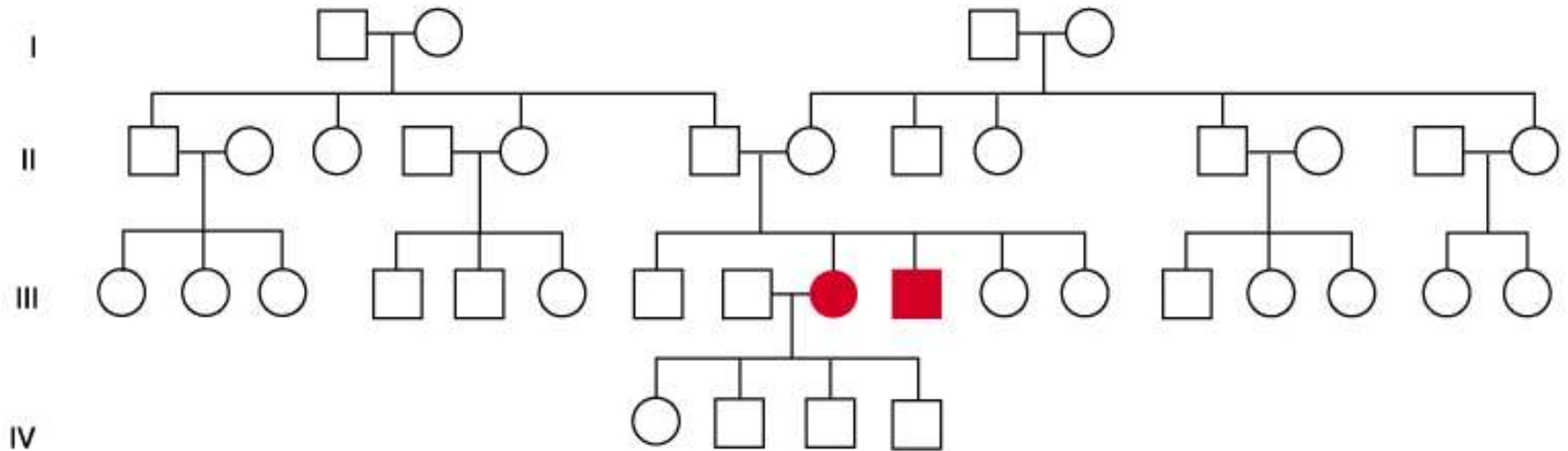

W.B. Saunders Company items and derived items copyright © 2002 by W.B. Saunders Company

# Features of Autosomal Recessive Inheritance

1. Horizontal transmission – affected individuals usually within the same sibship or generation
2. Both sexes affected in 1:1 ratio
3. Both sexes may equally transmit the mutant allele
4. May observe consanguinity
5. Gene product is usually an enzymatic protein

# Transmission probabilities and use of the Punnett square

If both parents are carriers ( $Aa \times Aa$ ) then there is  
25% chance that the child will have the disorder ( $aa$ )  
50% chance that the child will be a carrier ( $Aa$ ), and  
25% chance that the child will be neither affected nor a carrier ( $AA$ ).

Thus the chance that an unaffected child of carrier parents is also a carrier is two in three.

## Autosomal Recessive Inheritance

(Both Parents Carriers)

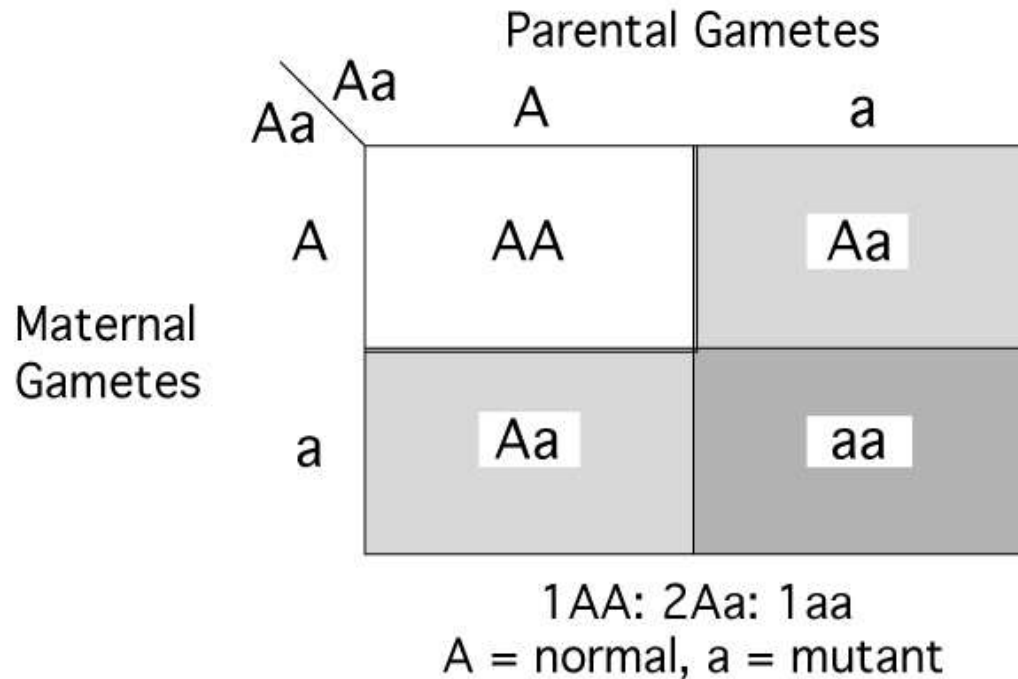

Affected homozygotes are commonly the offspring of two heterozygote carriers.